

DATA SHEET

7050

Reframe | Toilet paper holder

Toilet paper holder Brushed steel

The toilet roll is held in place with a removable part which is optimised in terms of friction so the paper rolls off perfectly. The toilet roll holder is reversible, and the removable part is magnetic, so it can be turned round quickly and easily.

The pack contains fittings, screws and an Unbraco key for assembly.



Specifications

ITEM NUMBER	GTIN NUMBER	WEIGHT
7050	5707692010670	400 g
MATERIAL	SURFACE	HEIGHT
Stainless steel (AISI 304)	Brushed steel	25 mm
DEPTH	WIDTH	
74 mm	191 mm	

DATA SHEET

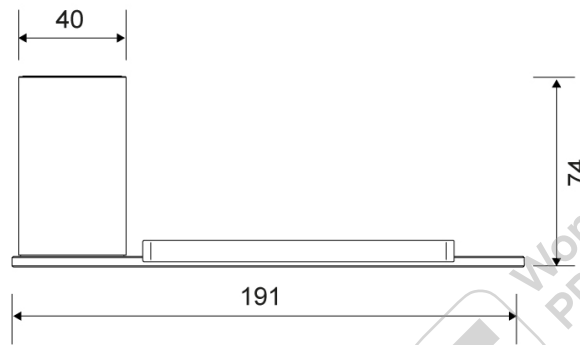
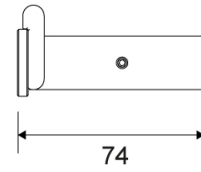
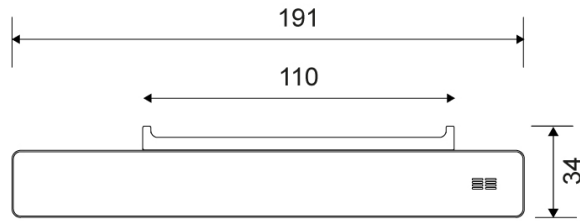

7050

Products

DATA SHEET

7051

Reframe | Toilet paper holder

Toilet paper holder Polished steel

The toilet roll is held in place with a removable part which is optimised in terms of friction so the paper rolls off perfectly. The toilet roll holder is reversible, and the removable part is magnetic, so it can be turned round quickly and easily.

The pack contains fittings, screws and an Unbraco key for assembly.



Specifications

ITEM NUMBER	GTIN NUMBER	WEIGHT
7051	5707692010687	400 g
MATERIAL	SURFACE	HEIGHT
Stainless steel (AISI 304)	Polished steel	25 mm
DEPTH	WIDTH	
74 mm	191 mm	

DATA SHEET

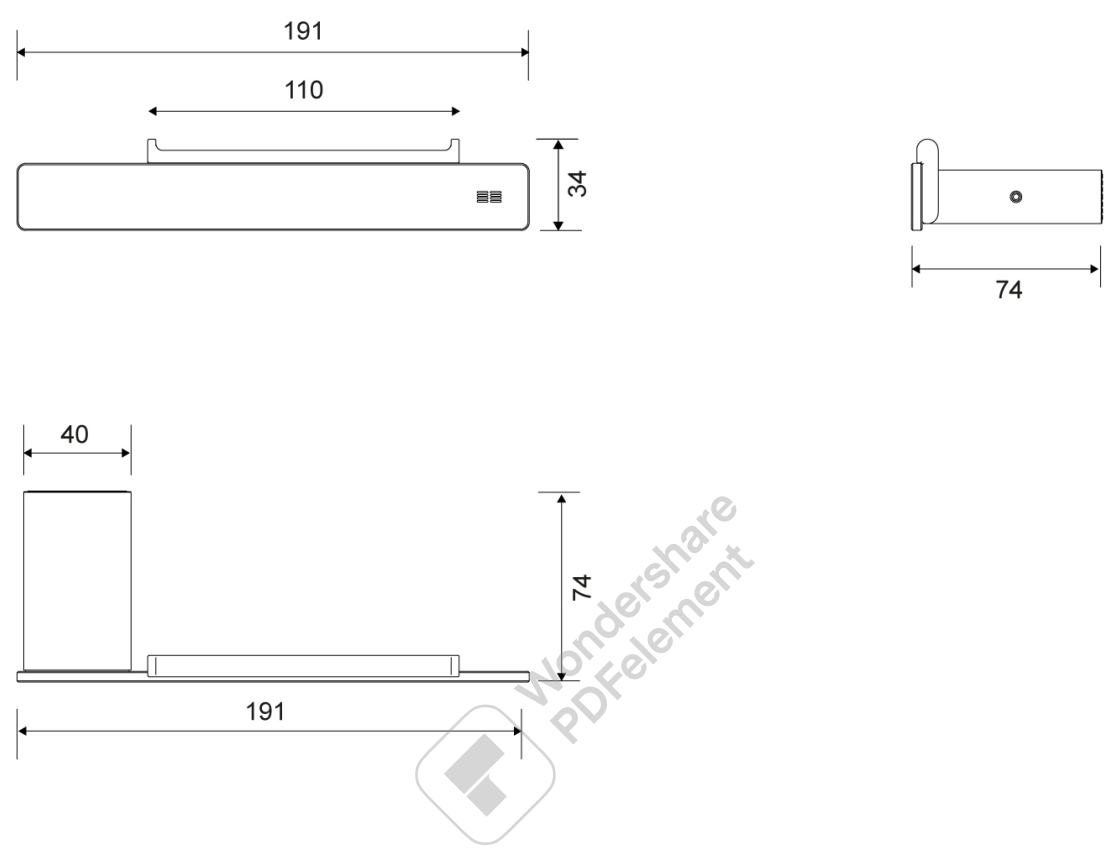

7051

Products

DATA SHEET

7052

Reframe | Toilet paper holder

Toilet paper holder Brass

The toilet roll is held in place with a removable part which is optimised in terms of friction so the paper rolls off perfectly. The toilet roll holder is reversible, and the removable part is magnetic, so it can be turned round quickly and easily.

The pack contains fittings, screws and an Unbraco key for assembly.



Specifications

ITEM NUMBER	GTIN NUMBER	WEIGHT
7052	5707692010694	400 g
MATERIAL	SURFACE	HEIGHT
Stainless steel (AISI 304)	PVD: Brass	25 mm
DEPTH	WIDTH	
74 mm	191 mm	

DATA SHEET

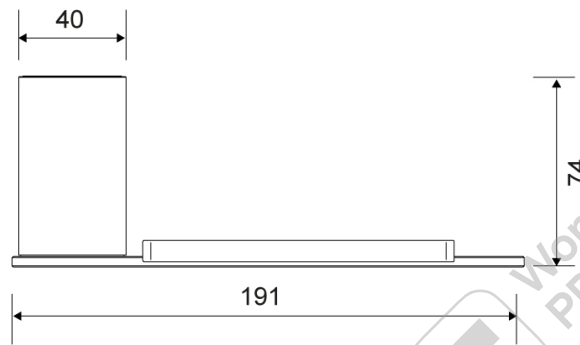
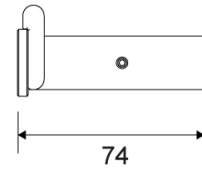
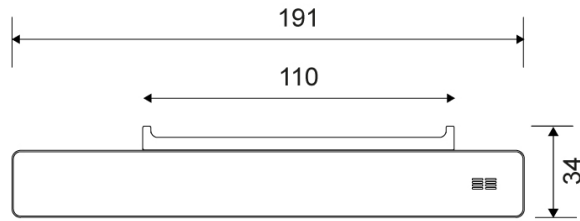

7052

Products

DATA SHEET

7053

Reframe | Toilet paper holder

Toilet paper holder Copper

The toilet roll is held in place with a removable part which is optimised in terms of friction so the paper rolls off perfectly. The toilet roll holder is reversible, and the removable part is magnetic, so it can be turned round quickly and easily.

The pack contains fittings, screws and an Unbraco key for assembly.



Specifications

ITEM NUMBER	GTIN NUMBER	WEIGHT
7053	5707692010700	400 g
MATERIAL	SURFACE	HEIGHT
Stainless steel (AISI 304)	PVD: Copper	25 mm
DEPTH	WIDTH	
74 mm	191 mm	

DATA SHEET

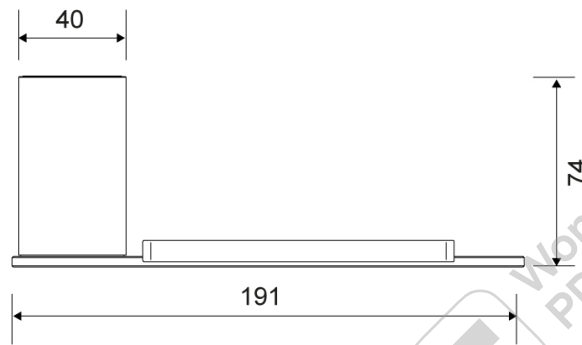
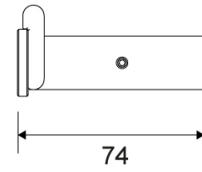
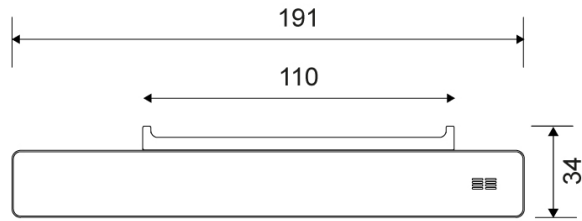

7053

Products

DATA SHEET

7054

Reframe | Toilet paper holder

Toilet paper holder Black

The toilet roll is held in place with a removable part which is optimised in terms of friction so the paper rolls off perfectly. The toilet roll holder is reversible, and the removable part is magnetic, so it can be turned round quickly and easily.

The pack contains fittings, screws and an Unbraco key for assembly.



Specifications

ITEM NUMBER	GTIN NUMBER	WEIGHT
7054	5707692010717	400 g
MATERIAL	SURFACE	HEIGHT
Stainless steel (AISI 304)	PVD: Black	25 mm
DEPTH	WIDTH	
74 mm	191 mm	

DATA SHEET

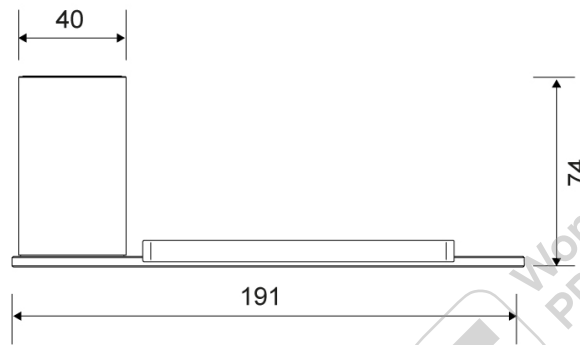
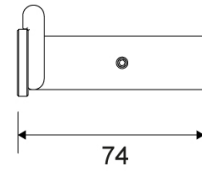
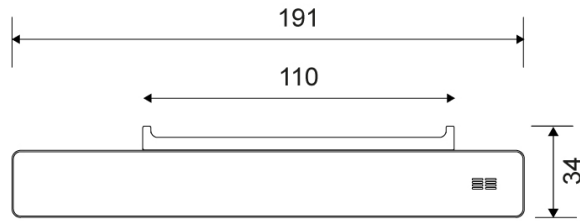

7054

Products